

# SELAMAT™

*Quality from the heart of Malaysia™*

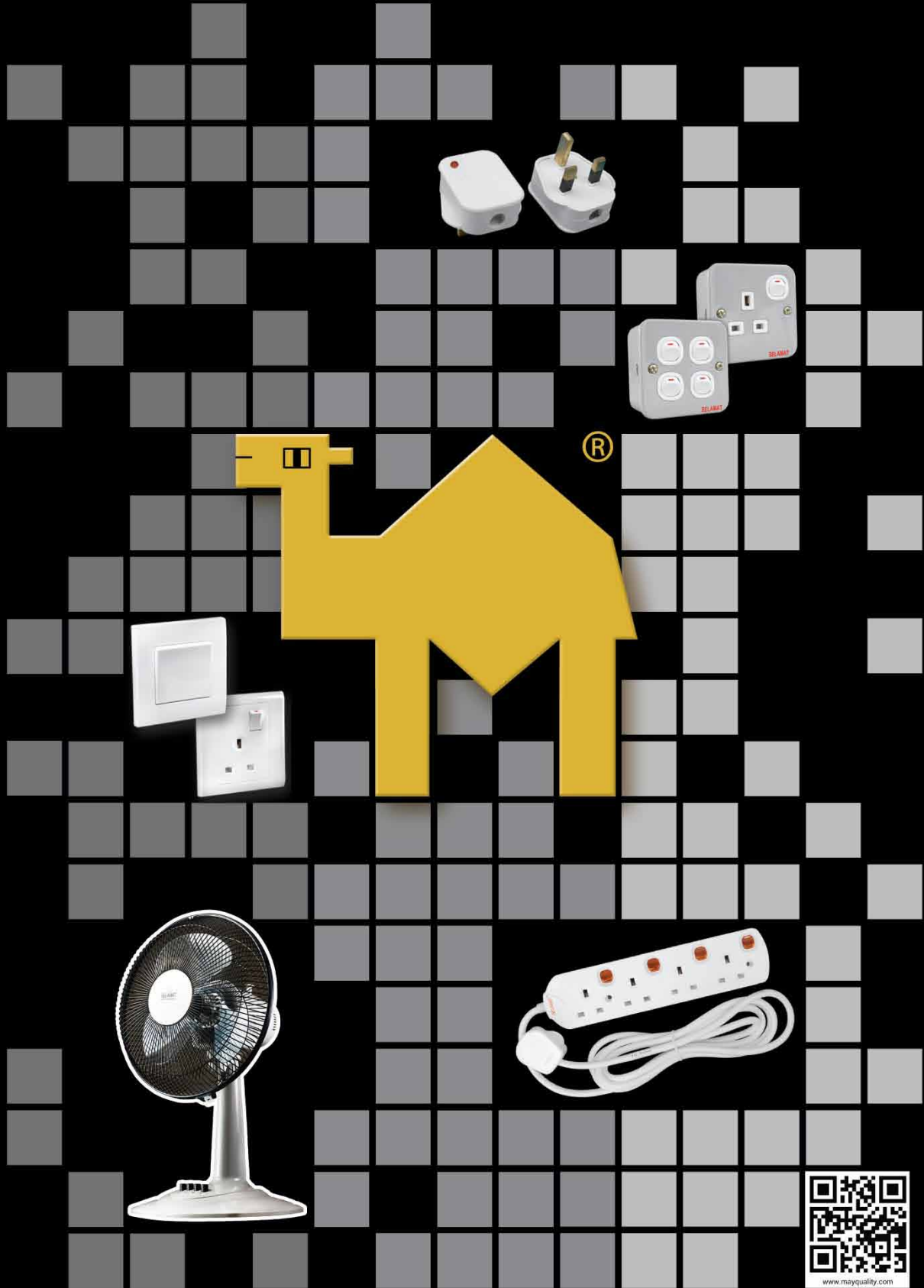

MADE IN MALAYSIA



[www.mayquality.com](http://www.mayquality.com)

# PRODUCT CATALOGUE

ELECTRICAL WIRING ACCESSORIES



### Contact Point

- Made of copper with selective silver plated
- Durable electrical contact up to 40,000 times switch on/off

### Rocker Spring

- Double Rocker Spring for better on/off switch movement

### Moving Contact

- Made of copper with selective silver plated
- For low resistance & high conductivity



## High Impact Resistance Polycarbonate (PC) with Fire Retardant & UV Stabilizer



### Nylon

- Fire resistant up to 850°C

### Contact Point

- Made of copper with selective silver plated
- Tested up to 15,000 times on/off switch movement

### Phosphorous Bronze L/N/E Pin Clips

- Tested up to 15,000 times plug insertion & withdrawal



Fire Retardant  
Materials



Heavy Duty  
Materials



Ultra Violet  
(UV) Protection



Made in  
Malaysia



ISO  
Certified



Environmentally  
Friendly



Low  
Toxicity



Quality  
Assurance



Minimum Chemical  
Emissions



RoHS  
Compliant

# Contents

- Flush Type Switches & Sockets - **MQ Series** ..... 4 - 6
- **2K Series** ..... 7 - 9
- **MS Series** ..... 10 - 11
- Telecommunication Outlets ..... 12
- Dimmer Switches & Controls ..... 13
- 2K Colour Series ..... 13
- Industrial Type Switches & Socket Outlets ..... 14 - 15
- Adaptors ..... 16
- Plug Tops ..... 17
- Portable Cable Reels ..... 17
- Portable Socket Outlets ..... 18
- Fan Series
  - **General Fans** ..... 19
  - **Industrial Fans** ..... 20
  - **Ventilating Fans** ..... 20
- Circuit Protection
  - **MCBs** ..... 21
  - **RCCBs** ..... 22
- Weatherproof Switch Isolators ..... 23
- LV Cut - Out Fuse Holders ..... 23
- Others Accessories ..... 23



## Product Certifications -



Certified to ISO 9001: 2008  
Cert. No.: AR 3510



Certified to ISO 14001: 2004  
Reg. No.: 77231171523

### MALAYSIA



Certified "MADE IN MALAYSIA"  
Products



Registered MATRADE  
Member



Standards and Industrial Research  
Institute of Malaysia (SIRIM)



Energy Commission of Malaysia  
(Suruhanjaya Tenaga)



Public Works Department of Malaysia  
(Jabatan Kerja Raya)

### SINGAPORE



Singapore Safety Mark - Consumer Protection  
(Safety Requirements) Registration Scheme

### KINGDOM OF SAUDI ARABIA



Saudi Arabian Standards Organization (SASO)

### UNITED ARAB EMIRATES



Emirate Conformity Assessment System

### BRUNEI DARUSSALAM



Department of Electrical Services  
Brunei Darussalam

### INTERNATIONAL



Conformity testing and Certification of Electrotechnical  
Equipment and Components (known as CB Scheme)



BUREAU  
VERITAS



# MQ SERIES

## FLUSH SWITCHES



### MQ 8101 - 1W

1 Gang 1 Way Switch  
16AX 250V

### MQ 8101 - 2W

1 Gang 2 Way Switch  
16AX 250V

### MQ 8101 - INT

1 Gang Intermediate Switch  
10AX 250V



### MQ 8102 - 1W

2 Gang 1 Way Switch  
16AX 250V

### MQ 8102 - 2W

2 Gang 2 Way Switch  
16AX 250V



### MQ 8103 - 1W

3 Gang 1 Way Switch  
16AX 250V

### MQ 8103 - 2W

3 Gang 2 Way Switch  
16AX 250V



### MQ 8104 - 1W

4 Gang 1 Way Switch  
16AX 250V

### MQ 8104 - 2W

4 Gang 2 Way Switch  
16AX 250V



### MQ 8101 - BELL

1 Gang Bell Switch  
10A 250V

### MQ 8102 - BELL

2 Gang Bell Switch  
10A 250V



### MQ 8101 - 20A

1 Gang 20A Double Pole Switch with Neon & Earth  
20A 250V

### MQ 8101 - 45A

1 Gang 45A Double Pole Switch with Neon & Earth  
45A 250V

# MQ SERIES

## SOCKET OUTLETS



### MQ 8131

13A 1 Gang Switched  
Socket Outlet  
13A 250V



### MQ 8131-DP

13A 1 Gang Double Pole  
Switched Socket Outlet  
13A 250V



### MQ 8132

13A 2 Gang Switched  
Socket Outlet  
13A 250V



### MQ 8132-DP

13A 2 Gang Double Pole  
Switched Socket Outlet  
13A 250V



### MQ 8131-NEON

13A 1 Gang Switched  
Socket Outlet with Neon  
13A 250V



### MQ 8131-NEON-DP

13A 1 Gang Double Pole  
Switched Socket Outlet  
with Neon  
13A 250V



### MQ 8132-NEON

13A 2 Gang Switched  
Socket Outlet with Neon  
13A 250V



### MQ 8132-NEON-DP

13A 2 Gang Double Pole  
Switched Socket Outlet  
with Neon  
13A 250V



### MQ 8151

15A Switched  
Socket Outlet  
15A 250V



### MQ 8151-NEON

15A Switched Socket  
Outlet with Neon  
15A 250V



### MQ 8131U

13A 1 Gang Universal  
Switched Socket Outlet  
13A 250V



### MQ 8131U-USB

13A 1 Gang Universal  
Switched Socket Outlet  
with USB Charging Port  
13A 250V /  
USB: 5 Vdc (700mA)





# MQ SERIES

## OTHER ACCESSORIES



### MQ 8101-TV

Single Coaxial TV Outlet



### MQ 8101-SAT

Single Cable TV Outlet (Satellite)



### MQ 8102-TV-SAT

Single Coaxial TV & Cable TV Outlet



### MQ 8101-TEL

Single RJ11 Cat 3 Telephone Outlet



### MQ 8101-COM

Single 8 Core RJ45 Cat.5e Data Outlet

### MQ 8102-COM

Double 8 Core RJ45 Cat.5e Data Outlet



### MQ 8101-CAT6

Single Category 6 Data Outlet

### MQ 8102-CAT6

Double Category 6 Data Outlet



### MQ 8101-USB

Single USB Power Charging Outlet  
USB: 5Vdc (1000mA)

### MQ 8102-USB

Double USB Power Charging Outlet  
USB: 5Vdc (1000mA)



### MQ 8500-D

500W Dimmer Switch  
500 W 250V



# SWITCHES - 2K Series

## TECHNICAL DATA

- High Impact Polycarbonate (PC) Surface
- Fire Retardant (FR) Body

- Ultra Violet (UV) Stable Material
- Comply to IEC 60660; BS 3676; SS 227



• **2K - 101**

1 Gang 1 Way Switch  
10AX 250V

• **2K - 101(2W)**

1 Gang 2 Way Switch  
10AX 250V

• **2K - 101(INT)**

1 Gang Intermediate Switch  
10AX 250V



• **2K - 102**

2 Gang 1 Way Switch  
10AX 250V

• **2K - 102(2W)**

2 Gang 2 Way Switch  
10AX 250V

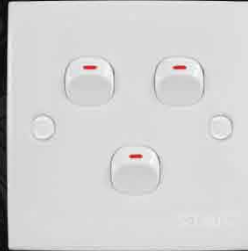

• **2K - 103**

3 Gang 1 Way Switch  
10AX 250V

• **2K - 103(2W)**

3 Gang 2 Way Switch  
10AX 250V

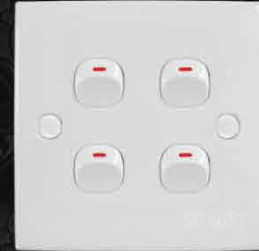

• **2K - 104**

4 Gang 1 Way Switch  
10AX 250V

• **2K - 104(2W)**

4 Gang 2 Way Switch  
10AX 250V



• **2K - 105**

5 Gang 1 Way Switch  
10AX 250V

• **2K - 105(2W)**

5 Gang 2 Way Switch  
10AX 250V



• **2K - 101 (BELL)**

1 Gang Bell Switch  
10AX 250V

• **2K - 102 (BELL)**

2 Gang Bell Switch  
10AX 250V

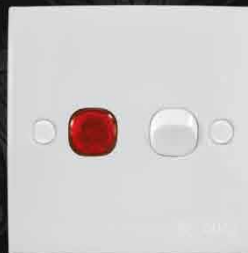

• **2K - 102(20A)**

1 Gang 20A Double Pole Switch with Neon  
(Water Heater/Air Cond)  
20A 250V



• **2K - 45L**

45A Double Pole Switch with Neon  
45A 250V

• **2K - 45LT**

45A Double Pole Switch with Italian System Screw Mounting Hole  
45A 250V



• **2K - 103 (R/G)**

2 Gang 2 Way Push Red & Green Switch with Neon  
10A 250V

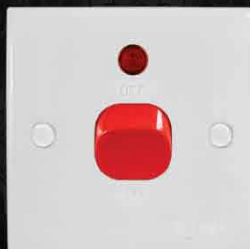

• **2K - 45**

45A Double Pole Switch with Neon  
45A 250V

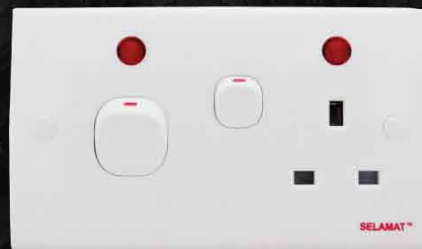

• **2K - 45(COOKER)**

45A Double Pole Switch & 13A Switched Socket Outlet with Neon  
250V



# SOCKET OUTLETS - 2K Series



## TECHNICAL DATA

- High Impact Polycarbonate (PC) Surface
- Fire Retardant (FR) Body

- Ultra Violet (UV) Stable Material
- Comply to BS 546; BS 1363; BS 5733; SS 145; SS 241; SS 472; MS 589; MS 1577



### • 2K - 131

13A 1 Gang Switched  
Socket Outlet  
13A 250V



### • 2K - 131 (NEON)

13A 1 Gang Switched  
Socket Outlet with Neon  
13A 250V

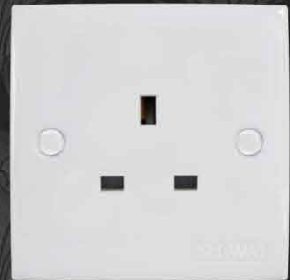

### • 2K - 131 (W/S)

13A 1 Gang  
Socket Outlet  
13A 250V



### • 2K - 151

15A 1 Gang Switched  
Socket Outlet  
15A 250V



### • 2K - 151 (NEON)

15A 1 Gang Switched  
Socket Outlet with Neon  
15A 250V



### • 2K - 151 (W/S)

15A 1 Gang  
Socket Outlet  
15A 250V



### • 2K - 132

13A 2 Gang Switched Socket Outlet  
13A 250V



### • 2K - 132 (NEON)

13A 2 Gang Switched Socket Outlet  
with Neon  
13A 250V



# SOCKET OUTLETS - 2K Series

## TECHNICAL DATA

- High Impact Polycarbonate (PC) Surface
- Fire Retardant (FR) Body

- Ultra Violet (UV) Stable Material



### • 2K - 1021

1 Gang 2 Pin  
Socket Outlet  
10A/16A 250V

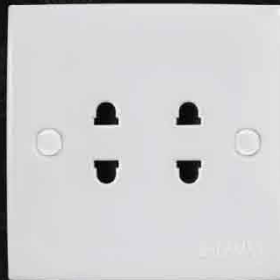

### • 2K - 1022

2 Gang 2 Pin  
Socket Outlet  
10A/16A 250V



### • 2K - 1021S

1 Gang 2 Pin Switched  
Socket Outlet  
10A/16A 250V

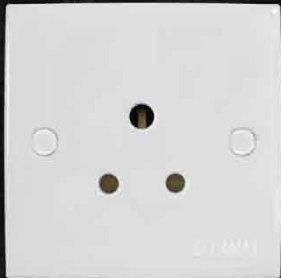

### • 2K - 51

5A 1 Gang Socket  
Outlet  
5A 250V



### • 2K - 51 S

5A 1 Gang Switched  
Socket Outlet  
5A 250V

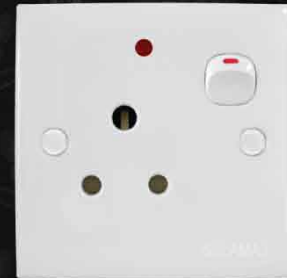

### • 2K - 51S (NEON)

5A 1 Gang Switched  
Socket Outlet with Neon  
5A 250V



### • 2K - 162

Single G - Type  
Flush Socket Outlet  
10A/ 16A



### • 2K - 131 U

1 Gang Universal  
Switched Socket Outlet  
13A 250V



### • 2K - 132 U

2 Gang Universal Switched  
Socket Outlet  
13A 250V

SOCKET OUTLETS - 2K Series



# SWITCHES / SOCKETS -MS Series

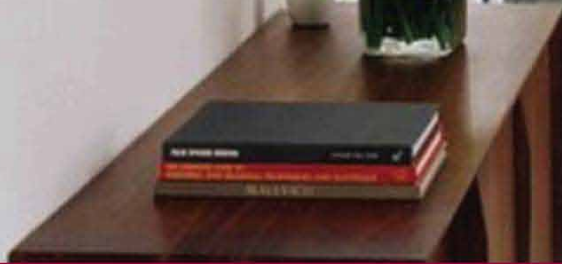

## TECHNICAL DATA

- High Impact Polycarbonate (PC) Surface
- Fire Retardant (FR) Body

- Ultra Violet (UV) Stable Material
- Comply to IEC 60669; BS 3676; BS 546; BS 1363; BS 5733; SS 145; SS 241; SS 472; SS 227; MS 589; MS 1577

## SWITCHES -MS Series



• **MS - 101L**  
1 Gang 1 Way Switch  
10AX 250V

• **MS - 101L(2W)**  
1 Gang 2 Way Switch  
10AX 250V



• **MS - 102L**  
2 Gang 1 Way Switch  
10AX 250V

• **MS - 102L(2W)**  
2 Gang 2 Way Switch  
10AX 250V



• **MS - 103L**  
3 Gang 1 Way Switch  
10AX 250V

• **MS - 103L(2W)**  
3 Gang 2 Way Switch  
10AX 250V



• **MS - 104L**  
4 Gang 1 Way Switch  
10AX 250V

• **MS - 104L(2W)**  
4 Gang 2 Way Switch  
10AX 250V



• **MS - 101L(BELL)**  
1 Gang Bell Switch  
10AX 250V



• **MS - 102L(20A)**  
1 Gang 20A Double Pole Switch  
20A 250V



• **2K - 13N**  
13A Switched Fused Connection Unit with Neon  
13A 250V

## SOCKET OUTLETS -MS Series



• **MS - 131L**  
13A 1 Gang Switched Socket Outlet  
13A 250V



• **MS - 132L (NEON)**  
13A 1 Gang Switched Socket Outlet with Neon  
13A 250V



• **MS - 151L**  
15A Switched Socket Outlet  
15A 250V



• **MS - 1021L**  
1 Gang 2 Pin Switched Socket Outlet  
16A 250V



# SOCKET OUTLETS



## TECHNICAL DATA

- High Impact Polycarbonate (PC) Surface
- Fire Retardant (FR) Body

- Ultra Violet (UV) Stable Material
- Comply to BS 1363; BS 5733; SS 145; SS 241; SS 472; MS 589; MS 1577

## SOCKET OUTLETS -MU Series



• **MS - 132L**  
13A 2 Gang  
Switched Socket Outlet  
13A 250V

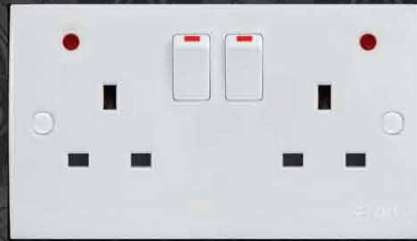

• **MS - 132L (NEON)**  
13A 2 Gang Switched  
Socket Outlet with Neon  
13A 250V



• **MU - 131**  
1 Gang Universal Socket Outlet  
13A 250V



• **MU - 131L**  
1 Gang Universal Switched  
Socket Outlet  
13A 250V

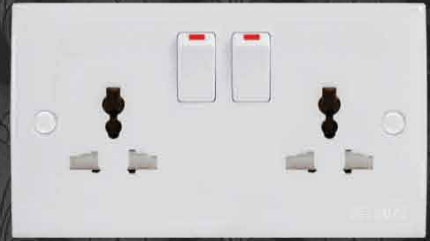

• **MU - 132L**  
2 Gang Universal Switched Socket Outlet  
13A 250V

## MINI -SOCKET OUTLETS -A Series



• **A - 3321**  
1 Gang Mini  
- Switched Socket Outlet  
13A 250V (70 x 60 mm)



• **A - 3322**  
2 Gang Mini -  
Switched Socket  
Outlet  
13A 250V  
(130 x 60 mm)



• **A - 3321N**  
1 Gang Mini -  
Switched Socket Outlet  
with Neon Switch  
13A 250V (70 x 60 mm)



• **A - 3322N**  
2 Gang Mini -  
Switched Socket Outlet  
with Neon Switch  
13A 250V  
(130 x 60 mm)



# TELECOMMUNICATION OUTLETS



## TECHNICAL DATA

- High Impact Polycarbonate (PC) Surface
- Fire Retardant (FR) Body
- Ultra Violet (UV) Stable Material



• **2K - 101 (TV)**  
Single Coaxial TV Outlet



• **2K - 101 (SAT)**  
Single Cable TV Outlet



• **2K - 102 (TV-S)**  
Single Coaxial TV & Cable TV Outlet



• **2K - 101 (TEL)**  
Single RJ11 Cat 3 Telephone Outlet



• **2K - 101 (COM)**  
Single 8 Core RJ45 Cat.5e Data Outlet



• **2K - 101 (CAT6)**  
Single Category 6 Data Outlet



• **2K - 102 (TEL-COM)**  
Single RJ11 Telephone Outlet & Cat.5e Data Outlet



• **2K - 101 (USB)**  
Single USB Power Charging Outlet  
USB: 5Vdc (1000mA)



• **2K - 102 (USB)**  
Double USB Power Charging Outlet  
USB: 5Vdc (1000mA)



# DIMMER SWITCHES & CONTROLS



## TECHNICAL DATA

- High Impact Polycarbonate (PC) Surface
- Fire Retardant (FR) Body

- Ultra Violet (UV) Stable Material
- Comply to MS IEC 60669



### • 2K - 163 (630W)

630W Dimmer control  
630W 250V

### • 2K - 163 (1000W)

1000W Dimmer control  
1000W 250V



### • 2K - 102 (F400)

400VA Fan  
Controller Switch  
400VA 250V



### • 2K - 102 (D500)

500VA Dimmer  
Controller Switch  
500VA 250V



### • 2K - 104 (D500)

500VA Double Dimmer  
Controller Switch  
500VA 250V

## 2K COLOUR SERIES



### • 2K - 101 C

1 Gang 1 Way Switch  
10AX 250V

### • 2K - 101 C (2W)

1 Gang 2 Way Switch  
10AX 250V



### • 2K - 103 C

2 Gang 1 Way Switch  
10AX 250V

### • 2K - 103 C (2W)

2 Gang 2 Way Switch  
10AX 250V



### • 2K - 103 C

3 Gang 1 Way Switch  
10AX 250V

### • 2K - 103 C (2W)

3 Gang 2 Way Switch  
10AX 250V



### • 2K - 104 C

4 Gang 1 Way Switch  
10AX 250V

### • 2K - 104 C (2W)

4 Gang 2 Way Switch  
10AX 250V



### • 2K - 105 C

5 Gang 1 Way Switch  
10AX 250V

### • 2K - 105(2W)

5 Gang 2 Way Switch  
10AX 250V

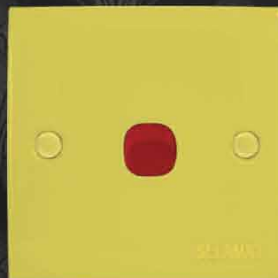

### • 2K - 101 C/C

1 Gang 1 Way Switch  
10AX 250V

### • 2K - 101(2W) C/C

1 Gang 2 Way Switch  
10AX 250V



### • 2K - 131 C/C

13A 1 Gang Switch  
Socket Outlet  
13A 250V

# INDUSTRIAL TYPE -2K7 Series

## TECHNICAL DATA

• Heavy Duty Metal Surface and Base

• Comply to IEC 60669; BS 1363; BS 546; SS 145; SS 472; MS 589; MS 1577



• 2K - 701

1 Gang 1 Way Surface Switch  
10AX 250V

• 2K - 701(2W)

1 Gang 2 Way Surface Switch  
10AX 250V



• 2K - 702

2 Gang 1 Way Surface Switch  
10AX 250V

• 2K - 702(2W)

2 Gang 2 Way Surface Switch  
10AX 250V



• 2K - 703

3 Gang 1 Way Surface Switch  
10AX 250V

• 2K - 703(2W)

3 Gang 2 Way Surface Switch  
10AX 250V



• 2K - 704

4 Gang 1 Way Surface Switch  
10AX 250V

• 2K - 704(2W)

4 Gang 2 Way Surface Switch  
10AX 250V



• 2K - 705

5 Gang 1 Way Surface Switch  
10AX 250V

• 2K - 705(2W)

5 Gang 2 Way Surface Switch  
10AX 250V



• 2K - 702 (20A)

1 Gang Double Pole Surface  
Switch with Neon  
20A 250V



• 2K - 701 (BELL)

Surface Bell Press



• 2K - 731

13A 1 Gang Surface  
Switched Socket Outlet  
13A 250V



• 2K - 751

15A Surface  
Switched Socket Outlet  
15A 250V



• 2K - 701 (TEL)

Single Surface  
RJ11 Telephone Outlet



• 2K - 732

13A 2 Gang Surface Switched Socket Outlet  
13A 250V

INDUSTRIAL TYPE -2K7 Series



# INDUSTRIAL TYPE -2K9Series



## TECHNICAL DATA

- Heavy Duty Polycarbonate (PC) Surface & Metal Base
- Comply to IEC 60669; BS 1363; BS 546; SS 145; MS 472; MS 589; MS 1577

- Ultra Violet (UV) & Fire Retardant (FR) Surface



### • 2K - 901

1 Gang 1 Way Surface Switch  
10AX 250V

### • 2K - 901(2W)

1 Gang 2 Way Surface Switch  
10AX 250V



### • 2K - 902

2 Gang 1 Way Surface Switch  
10AX 250V

### • 2K - 902(2W)

2 Gang 2 Way Surface Switch  
10AX 250V



### • 2K - 903

3 Gang 1 Way Surface Switch  
10AX 250V

### • 2K - 903(2W)

3 Gang 2 Way Surface Switch  
10AX 250V



### • 2K - 904

4 Gang 1 Way Surface Switch  
10AX 250V

### • 2K - 904(2W)

4 Gang 2 Way Surface Switch  
10AX 250V



### • 2K - 905

5 Gang 1 Way Surface Switch  
10AX 250V

### • 2K - 905(2W)

5 Gang 2 Way Surface Switch  
10AX 250V



### • 2K - 902 (20A)

1 Gang Double Pole Surface  
Switch with Neon  
20AX 250V



### • 2K - 901 (BELL)

Surface Bell Press



### • 2K - 931

13A 1 Gang Surface  
Switched Socket Outlet  
13A 250V



### • 2K - 951

15A Surface  
Switched Socket Outlet  
15A 250V



### • 2K - 901 (TEL)

Single Surface RJ11 Telephone  
Outlet



### • 2K - 932

13A 2 Gang Surface Switched Socket Outlet  
13A 250V

INDUSTRIAL TYPE -2K9Series

# ADAPTORS

## TECHNICAL DATA

- High Impact Polycarbonate (PC) Surface
- Fire Retardant (FR) Body
- Comply to BS 1363; BS 5733; SS 246; MS 589; MS 1144
- Ultra Violet (UV) Stable Material
- Fitted with UK Certified Fuse

## EXCELLENT DESIGN

for Euro 240V 2 Pin Plug



### • MA - 8322 (SURGE)

8 Way T-Type Multi Adaptor with Surge Protector  
13A 250V  
Pattern Right Reg. No. MY 09-00553-0106



### • MA - 8322 (USB & SURGE)

8 Way T-Type Multi Adaptor with USB Charging Port & Surge Protector  
13A 250V  
USB: 5 Vdc(700mA)  
Pattern Right Reg. No. MY 09-00554-0206



### • NP - 228 N

3 Way Universal Adaptor with Neon  
250V

### • NP - 228

3 Way Universal Adaptor  
250V



### • 2K - 933N

3 Way Multi-Adaptor with Neon & 13A Fuse  
13A 250V

### • 2K - 933

3 Way Multi-Adaptor with 13A Fuse  
13A 250V



### • SA - 32

3 Way Multi-Adaptor with LED Switch & 13A Fuse  
13A 250V

Pattern Right Reg. No. MY 10-00582-0101



### • 2K - 227

Universal Travel Adaptor with Surge Protector & USB Charging Port  
Pattern Right Reg. No. MY 09-00556-0406



### • 2K - 229

Universal Travel Adaptor with Surge Protector





# PLUG TOPS



## TECHNICAL DATA

- High Impact Polycarbonate (PC) Surface
- Fire Retardant (FR) Body
- Fitted with UK Certified Fuse

- Ultra Violet (UV) Stable Material
- Comply to BS 546; BS 1363; SS 145; SS 472; MS 589; MS 1577



### • MA - 18

13Amp Rewireable Fused Plug  
13A 250V



### • MA - 18 NEON

13Amp Rewireable Fused Plug with Neon  
13A 250V



### • MA - 28

13A Rewireable Fused Plug  
13A 250V



### • MA - 15

15A Rewireable Fused Plug  
15A 250V

PLUGTOPS

# PORTABLE CABLE REELS

## TECHNICAL DATA

- Socket Outlet & Plug Top: High Impact Polycarbonate (PC) with Fire Retardant & UV Stabilizer
- Pure Copper Cable & Components approved by SIRIM (Malaysia) & PSB (Singapore)

- Fire Retardant Body
- High Quality Plug Top Fitted with UK Certified Fuse
- Comply to SS 307



### • 2K - 211H (ELCB)

1 Gang Portable Cable Reel with Circuit Breaker  
13A 250V



### • 2K - 222H (ELCB)

2 Gang Portable Cable Reel with Circuit Breaker  
13A 250V



### • 2K - 211H

1 Gang Portable Cable Reel  
13A 250V



### • 2K - 222H

2 Gang Portable Cable Reel  
13A 250V

# PORTABLE SOCKET OUTLETS

## BS Standard Trailing Socket

### TECHNICAL DATA

- High Impact Polycarbonate (PC) Surface
- Fire Retardant (FR) Body
- Pure Copper Cable & Components approved by SIRIM (Malaysia) & PSB (Singapore)
- Ultra Violet (UV) Stable Material
- High Quality Plug Top Fitted with UK Certified Fuse
- Comply to BS 1363; SS 145; MS 589

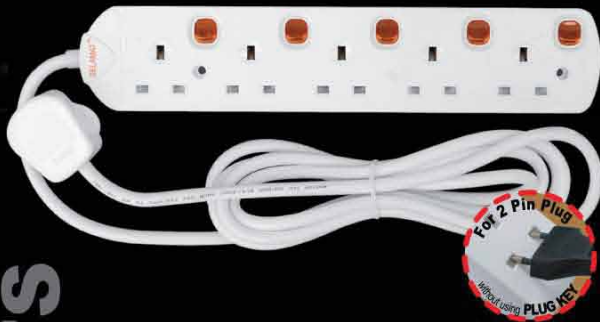

#### • MA - 1182

2 Gang Portable Switch Socket Outlet with Individual Neon Switch  
13A 250V

#### • MA - 1183

3 Gang Portable Switch Socket Outlet with Individual Neon Switch  
13A 250V

#### • MA - 1184

4 Gang Portable Switch Socket Outlet with Individual Neon Switch  
13A 250V

#### • MA - 1185

5 Gang Portable Switch Socket Outlet with Individual Neon Switch  
13A 250V

#### • MA - 1186

6 Gang Portable Switch Socket Outlet with Individual Neon Switch  
13A 250V

# Available with  
**SURGE PROTECTOR**

## UNIVERSAL Trailing Socket

### TECHNICAL DATA

- High Impact Polycarbonate (PC) Surface
- Fire Retardant (FR) Body
- Ultra Violet (UV) Stable Material
- High Quality Plug Top Fitted with UK Certified Fuse
- Pure Copper Cable & Components approved by SIRIM (Malaysia) & PSB (Singapore)

#### • MA - 1132

2 Gang Universal Portable Switch Socket Outlet with Individual Neon Switch  
13A 250V

#### • MA - 1133

3 Gang Universal Portable Switch Socket Outlet with Individual Neon Switch  
13A 250V

#### • MA - 1134

4 Gang Universal Portable Switch Socket Outlet with Individual Neon Switch  
13A 250V

#### • MA - 1135

5 Gang Universal Portable Switch Socket Outlet with Individual Neon Switch  
13A 250V

#### • MA - 1136

6 Gang Universal Portable Switch Socket Outlet with Individual Neon Switch  
13A 250V

# Available with  
**SURGE PROTECTOR**



## OTHER MODELS



#### • LN - 2344

4 Gang Portable Switch Socket Outlet with Individual Neon Switch  
13A 250V

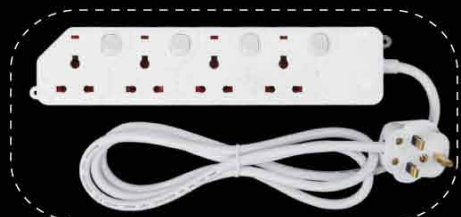

#### • MSL - 1352

4 Gang Portable Switch Socket Outlet with Individual Neon Switch



# FAN SERIES



## GENERAL FANS



**12" TABLE FAN**  
**MQ-P12T**

- \*45 watts durable motor
- \*3-speed push button control
- \*Smooth oscillation function
- \*Thermal safety fuse



**16" TABLE FAN**  
**MQ-P16T**

- \*55 watts durable motor
- \*3-speed push button control
- \*Smooth oscillation function
- \*Thermal safety fuse



**16" WALL FAN**  
**MQ-P16W**

- \*55 watts durable motor
- \*3-speed pull control
- \*Smooth oscillation function
- \*Thermal safety fuse



**16" STAND FAN**  
**MQ-P16ST**

- \*55 watts durable motor
- \*3-speed push button control
- \*Adjustable height up to 149cm
- \*Timer control
- \*Thermal safety fuse



**16" TORNADO 2 IN 1 FAN**

- \*55 watts durable motor
- \*Table & wall mounted use
- \*5-blade design
- \*3-speed control
- \*Smooth oscillation function

**MQ-P216TW2**



**MQ-P216TW**



**16" AUTO FAN**  
**MQ-A16**

- \*55 watts durable motor
- \*3-speed control
- \*Smooth oscillation function
- \*Thermal safety fuse

**FAN SERIES**



# FAN SERIES



## INDUSTRIAL FANS



MQ-116F



MQ-120W



MQ-118S

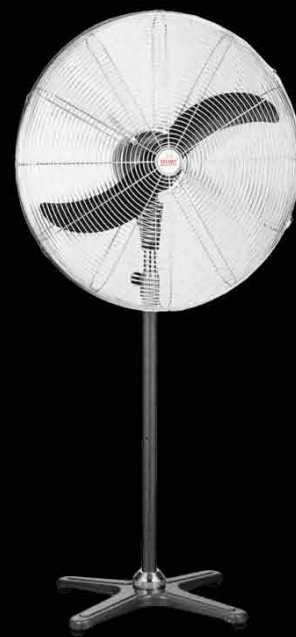

MQ-126S



MQ-118F



MQ-126W

Description	Model	Size	Power (watts)
16" Industrial Floor & Wall Fan	MQ-116F	16" (40cm)	100
18" Industrial Floor & Wall Fan	MQ-118F	18" (45cm)	90
18" Industrial Stand Fan	MQ-118S	18" (45cm)	90
20" Industrial Wall Fan	MQ-120W	20" (50cm)	120
26" Industrial Stand Fan	MQ-126S	26" (65cm)	190
26" Industrial Wall Fan	MQ-126W	26" (65cm)	190



## VENTILATING FANS

- Wall Mounted Type Ventilating Fan
- Low noise operation
- Energy-saving, high performance motor
- Simple installation and maintenance
- Thermal safety fuse

Description	Model	Size	Power (watts)
6" Ventilating Fan	MQ-V6	6" (15cm)	25
8" Ventilating Fan	MQ-V8	8" (20cm)	30
10" Ventilating Fan	MQ-V10	10" (25cm)	40
12" Ventilating Fan	MQ-V12	12" (30cm)	45



# CIRCUIT PROTECTION



## Miniature Circuit Breakers (MCBs)



Breaking Current	No. of Pole	Model	Rated Current
6,000A	1 Pole	MEC61	6A, 10A, 16A, 20A, 32A, 40A, 50A, 63A
	2 Pole	MEC62	6A, 10A, 16A, 20A, 32A, 40A, 50A, 63A
	3 Pole	MEC63	6A, 10A, 16A, 20A, 32A, 40A, 50A, 63A
10,000A	1 Pole	MEC101	6A, 10A, 16A, 20A, 32A, 40A, 50A, 63A
	2 Pole	MEC102	6A, 10A, 16A, 20A, 32A, 40A, 50A, 63A
	3 Pole	MEC103	6A, 10A, 16A, 20A, 32A, 40A, 50A, 63A



### Description:

- For protection against overload and short circuit in the electrical distribution system.
- The tripping mechanisms comprising of bi-metal for overload tripping protection and an electromagnetic tripping device to act against short circuit conditions.
- Use in domestic, commercial and industrial installations.



### Connection:

- Terminal: Pillar terminal with clamp
- Capacity: Rigid conductor up to 25mm<sup>2</sup>
- Available for both comb bar and fork bar

### Installation:

- On symmetrical DIN rail 35mm
- Panel mounting



### Approvals:

CB, CE, SIRIM, ST

### Technical Parameter

Standard	IEC/EN 60898
Number of Pole	1, 2, 3, 4 Pole
Rated Voltage	240/415V
Rated Current	6A, 10A, 16A, 20A, 32A, 40A, 50A, 63A
Rated Frequency	50/60Hz
Breaking Capacity	6,000A/ 10,000A
Tripping Curve	B, C, D
Mechanical Life	10,000/ 20,000
Electrical Life	4000 cycles
IP Rating	20

### Part Dimension

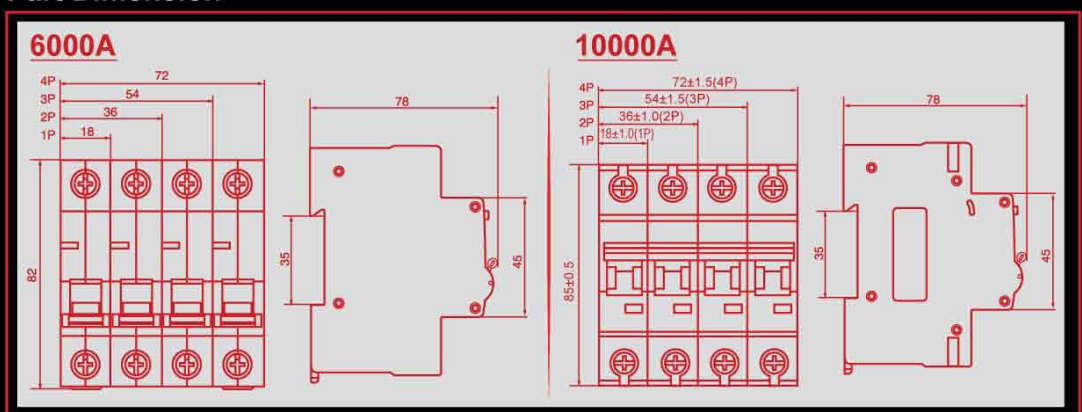

# CIRCUIT PROTECTION



## Residual Current Circuit Breakers (RCCBs)



Breaking Current	No. of Pole	Model		
6,000A	1P+N	MEL2030	16A,25A,32A,40A,63A	30mA
		MEL2100	16A,25A,32A,40A,63A	100mA
		MEL2300	16A,25A,32A,40A,63A	300mA
6,000A	3P+N	MEL4030	16A,25A,32A,40A,63A	30mA
		MEL4100	16A,25A,32A,40A,63A	100mA
		MEL4300	16A,25A,32A,40A,63A	300mA

### Description:

- To open a circuit automatically in the event of an earth leakage fault between phase and earth and/or neutral and earth. With effective protection against human contact to earth points.
- Use in domestic, commercial and industrial installations.

### Connection:

- Terminal: Pillar terminal with clamp
- Capacity: Rigid conductor up to 35mm<sup>2</sup>
- Available for both comb bar and fork bar

### Installation:

- On symmetrical DIN rail 35mm
- Panel mounting

### Approvals:

CB, CE, SIRIM, ST

### Technical Parameter

Standard	IEC/EN 61008
Number of Pole	1P+N, 3P+N
Rated Voltage	240/415V
Rated Current	16A, 25A, 40A, 63A
Rated Frequency	50/60Hz
Rated Conditional Short-Circuit Current	6,000A
Rated Tripping Current	30, 100, 300mA
Operating Characteristics	Type AC and Type A
Mechanical Life	10,000
Electrical Life	4000 cycles
IP Rating	20

### Part Dimension

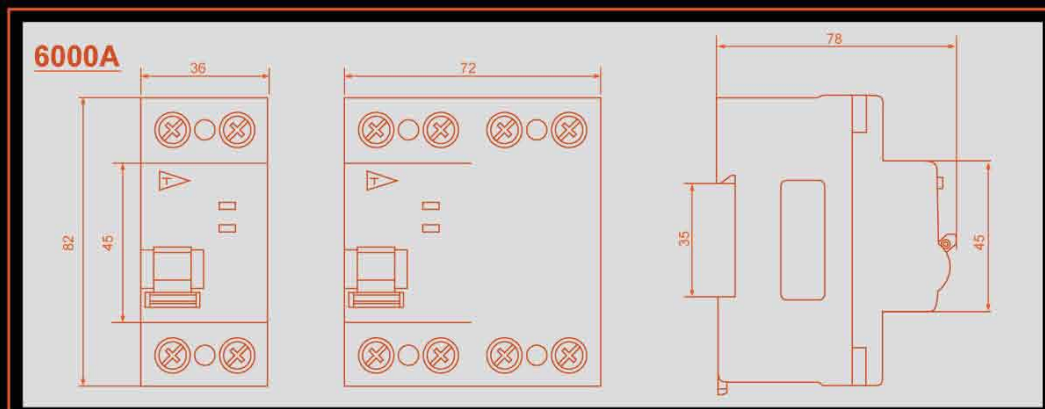



# WEATHERPROOF SWITCH ISOLATOR

## TECHNICAL DATA

- High Impact Polycarbonate (PC) Surface
- Fire Retardant (FR) Body
- Ultra Violet (UV) Stable Material
- Comply to IEC 60947-3.1P66.



### • WM - 220

2 Pole 20A Switch Isolator  
20A 240V

### • WM - 363

3 Pole 63A Switch Isolator  
63A 415V

### • WM - 445

4 Pole 45A Switch Isolator  
45A 415V

### • WM - 320

3 Pole 20A Switch Isolator  
20A 415V

### • WM - 420

4 Pole 20A Switch Isolator  
20A 415V

### • WM - 463

4 Pole 63A Switch Isolator  
63A 415V

### • WM - 332

3 Pole 32A Switch Isolator  
32A 415V

### • WM - 432

4 Pole 32A Switch Isolator  
32A 415V

# LV CUT-OUT FUSE HOLDERS

## TECHNICAL DATA

- Fuse Holders are tested by CPRI, India to IEC 60269



### • 2K-60C

60A Fuse Holder  
60A 240/415V



### • 2K-100C

100A Fuse Holder  
100A 240V



### • MD-100C

100A (Din Type) Fuse Disconnecter  
100A 240/415V



### • 2K-610N

Neutral Link  
60A/100A 240/415V

# OTHER ACCESSORIES

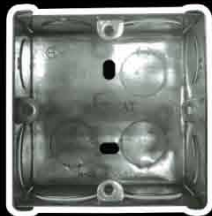

### • MB-3x3

3" x 3" Concealed Metal Box



### • MB-3x6

3" x 6" Concealed Metal Box



### • MB-3x7

3" x 7" Concealed Metal Box



### • MB-33

1 Gang PC Moulded Surface Box

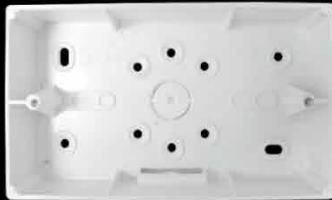

### • MB-36

2 Gang PC Moulded Surface Box

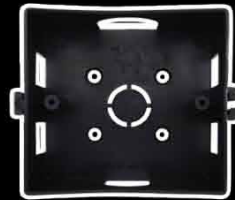

### • MC - 330

Connectable Concealed Box

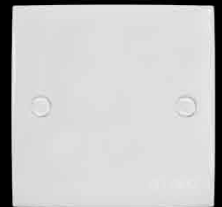

### • 2K - 100

1 Gang Blank Plate



### • 13A FUSE

SELAMAT™ 13A Fuse  
Approved by Asta  
Standard: BS 1362



### • MH-203

Wedge Holder 5Amp  
5A 250V



### • MH-202

Pendant Lamp Holder  
2A 250V



### • ME - 100

Splash Proof Cover

# PRODUCT CATALOGUE

ELECTRICAL WIRING ACCESSORIES

# PRODUCT

PRODUCT



**MALAYSIA**

**MAY QUALITY INDUSTRIES SDN BHD**  
(843377-W)



[www.mayquality.com](http://www.mayquality.com)

**OFFICE**

TL 48, Jalan Sri Tanjung,  
Parit Pinang Seribu,  
84150 Muar,  
Johor, Malaysia.  
Tel : +606-987 2222  
Fax : +606-987 2111

**FACTORY**

PTD6304, Jalan Poh Ai,  
Kampung Baru,  
84800 Bukit Gambir,  
Johor, Malaysia.  
Tel : +606-976 6666  
Fax : +606-976 6667

Email : [enquiry@mayquality.com](mailto:enquiry@mayquality.com)  
Website : [www.mayquality.com](http://www.mayquality.com)

